

BODY ENCLOSURE

BASE

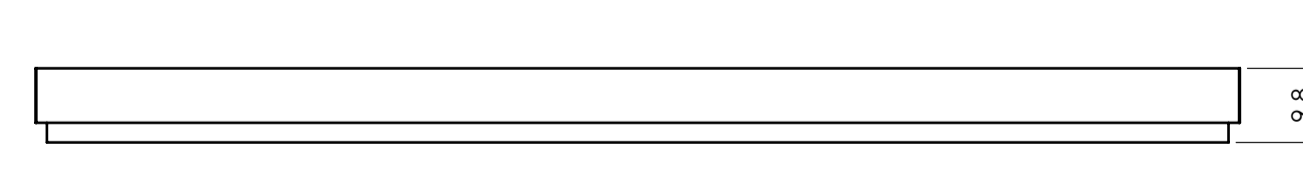

HOOK

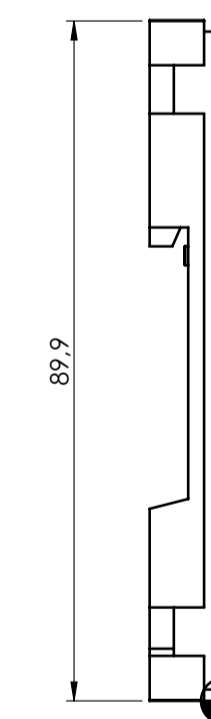
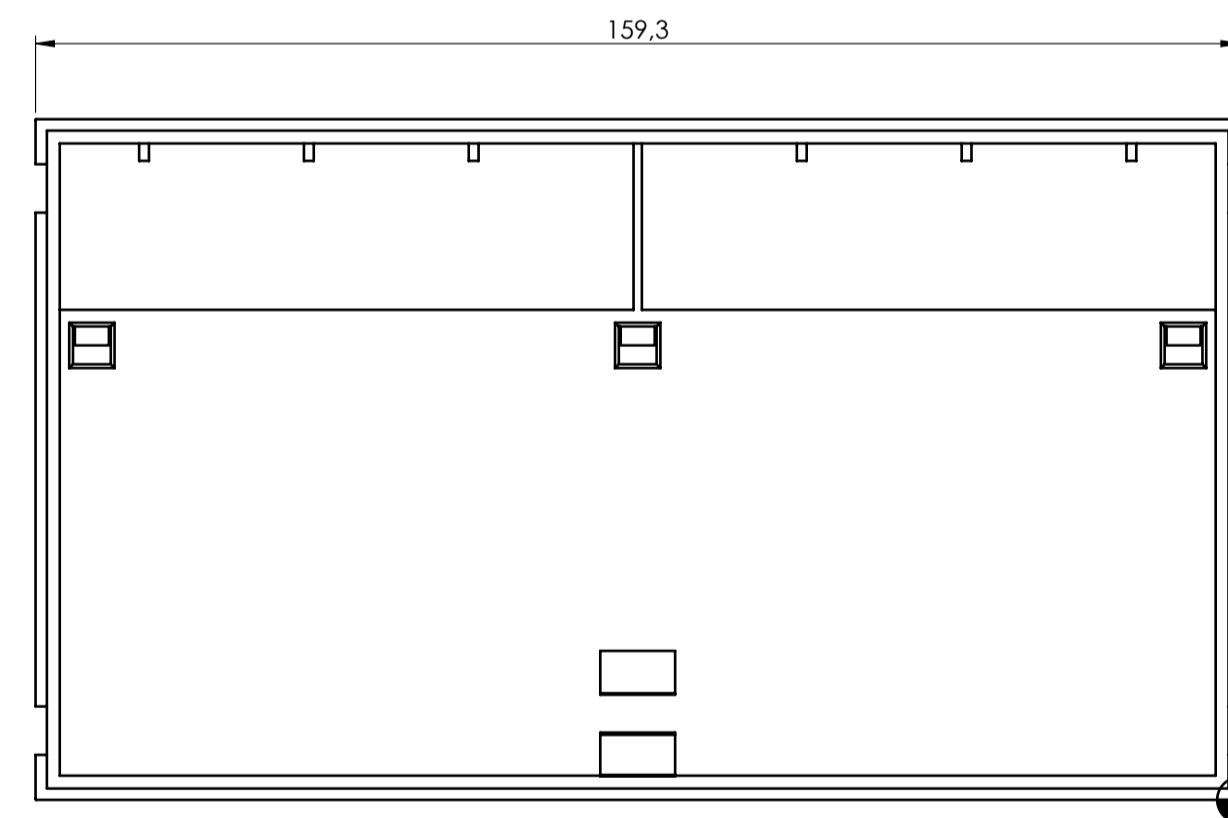
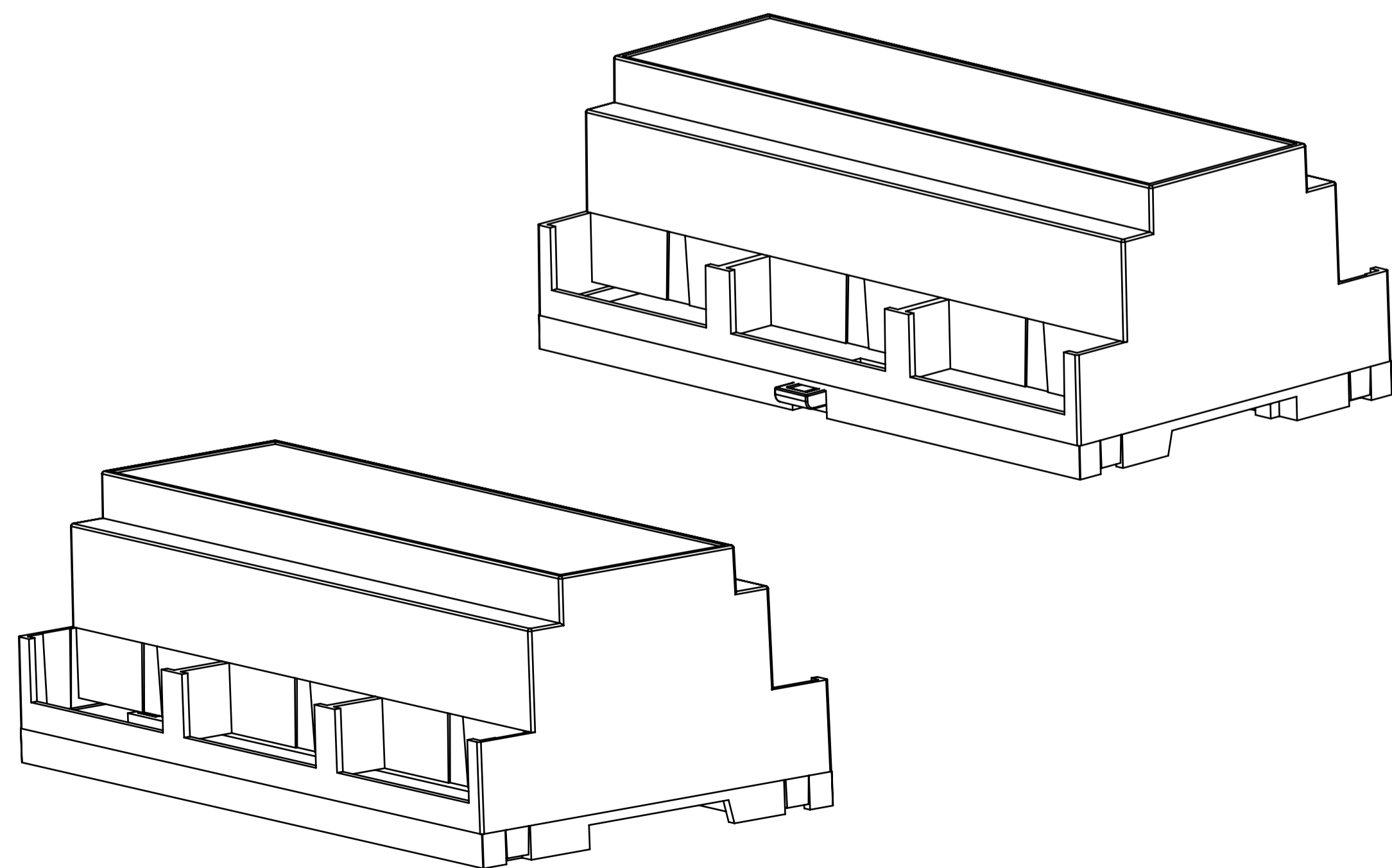
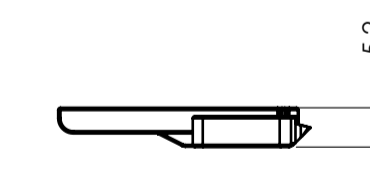
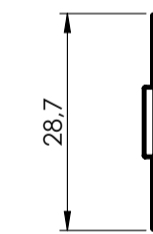
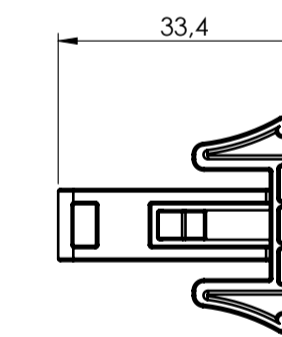

General information:
 - Workpiece zero point for mechanical processing
 - Minimum recommended radius for machining = R1.0 mm
 - Mounting rail like EN 60715; TH 35-7.5 or TH 35-15
 - Recommended PCB outline on www.italtronic.com

| RIF. | Q.TY | DRAWING | DESCRIPTION |
|------|------|-------------|-------------------------------------------------------|
| 1 | 1 | 2_250_03848 | BODY ENCLOSURE MODULBOX ONE 9MDHC53: STAMPO NERCOS |
| 2 | 1 | 2_250_00079 | HOOK FOR MODULBOX ONE |
| 3 | 1 | 2_250_00192 | BASE MODULBOX ONE 9M |

| Dimension in mm | from 0.5 to 3 | from 3 to 6 | from 6 to 30 | from 30 to 120 | from 120 to 400 | Sheet |
|-----------------|---------------|-------------|--------------|----------------|-----------------|-------|
| ±0.1 | ±0.1 | ±0.2 | ±0.3 | ±0.5 | 1 | |

| Scale: | Drawn: | Checked: | Date: | Material: | Process: |
|--------|--------|----------|------------|-----------|----------|
| 1:1 | M.S. | R.N. | 26/07/2023 | | |

| Replaces the: | Derived from: | Weight: | Cod. Mold: |
|---------------|---------------|---------|------------|
| M-04832-01 | -- | gr | -- |

| Description: | Drawing nr. | Rev: |
|--------------------------------------------------------------------------|-------------|------|
| KIT CONTENITORE MODULBOX ONE 9MDC53 KIT ENCLOSURE MODULBOX ONE 9MDC53 | 3_250_00168 | 01 |



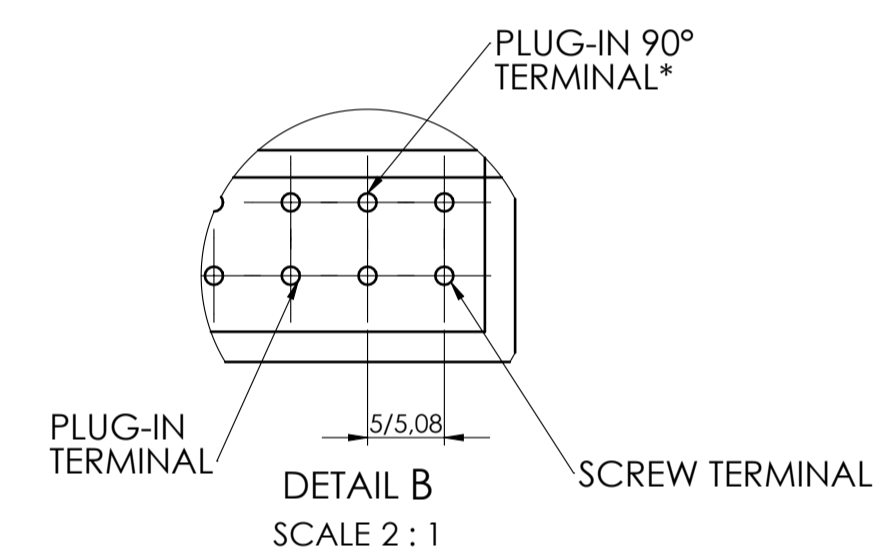
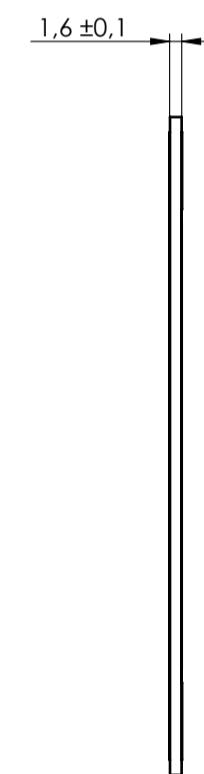
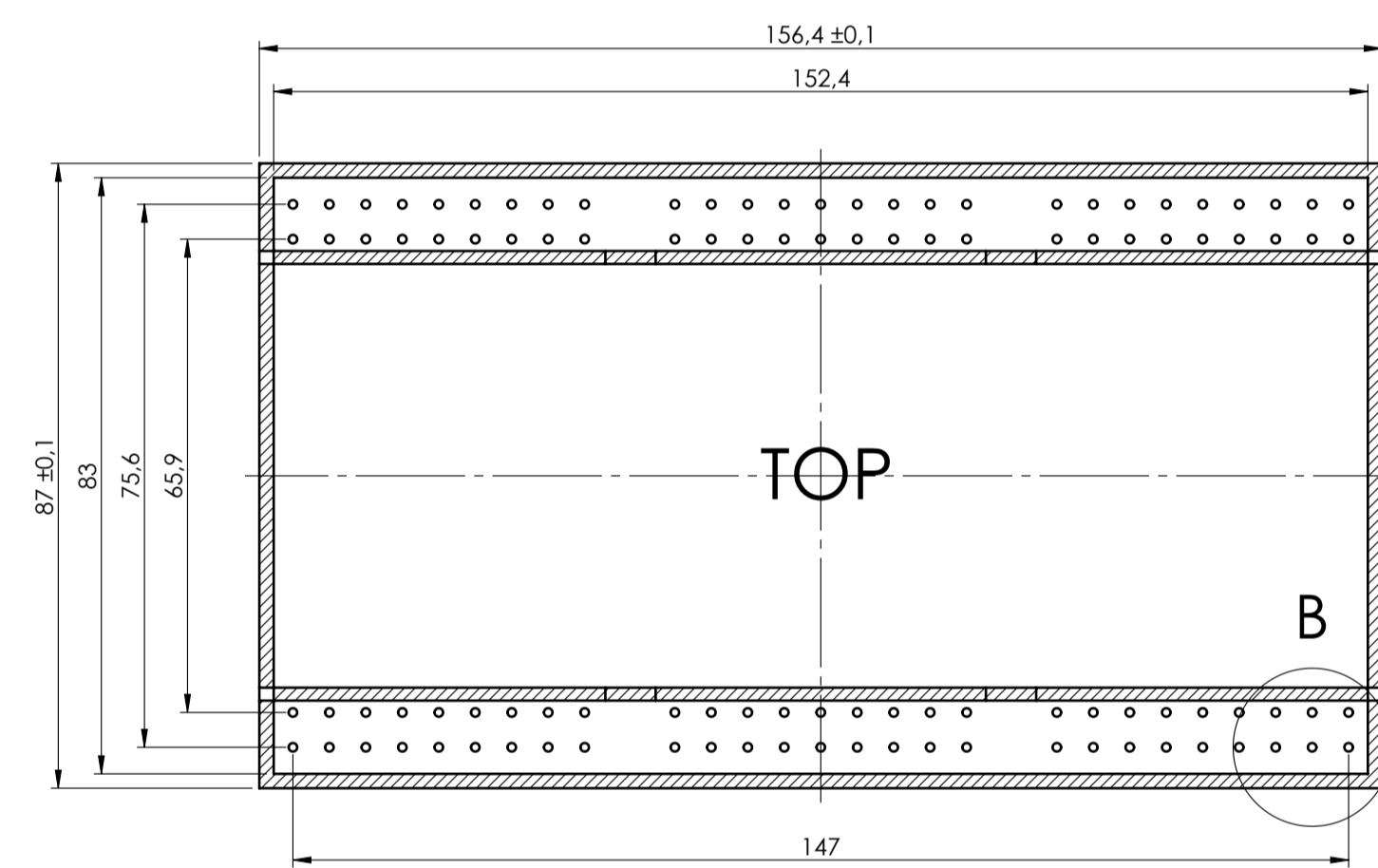

Max height of the terminal:
Modulbox ONE: 20 mm

PCB A

*To use the PLUG-IN terminals in Modulbox ONE use plug-in adapter P05000003E (5/5.08 pitch) and P05000004E (7.5/7.62 pitch)

| General Tolerance IIR EN 22768/1 Media [m] | | | | Sheet: | |
|--------------------------------------------|--------------------------------------------------------------------------|-----------------------|-------------------------|--------------------------|------|
| from 0.5 to 3 ± 0.1 | from 3 to 6 ± 0.1 | from 6 to 30 ± 0.2 | from 30 to 120 ± 0.3 | from 120 to 400 ± 0.5 | PCB |
| Scale: | 1:1 | Drawn: | M.S. | Checked: | R.N. |
| | | Date: | 26/07/2023 | Material: | |
| Dimension in mm | Description: | | Weight: | Cod. Mold: | |
| | KIT CONTENITORE MODULBOX ONE 9MDC53 KIT ENCLOSURE MODULBOX ONE 9MDC53 | | gr | -- | |
| | Derived from: | | | | |
| | 3_250_00168 | | | | |
| | Rev: | | | | |
| | 01 | | | | |

NO COMPONENTS AREA



enclosures for electronics
3_250_00168