

A WORLD OF ENCLOSURES

# iTouch

2016

[www.italtronic.com](http://www.italtronic.com)

2016 - REV01

**italtronic**  
enclosures for electronic



## CARATTERISTICHE GENERALI

### Contenitore per Domotica 80x120x10; 15; 25

**Materiale:** ABS autoestinguente

La linea iTouch è adatta per molteplici applicazioni ed è suddivisa in tre estetiche principali: iShape, std Shape e CSF.

La prima estetica denominata iShape è quella più flessibile perché accetta sul frontale diversi tipi di pannello: plastico, in vetro o con funzione touch panel integrata.

La seconda versione, STD Shape, è quella più semplice perché non è necessario l'impiego di un pannello ma è sufficiente l'equipaggiamento con il display con funzione touch panel integrato.

L'ultima, denominata CSF è invece più simile alle applicazioni tradizionali, con colori e materiali coordinati e il pannello anteriore cieco adatto a lavorazioni meccaniche e stampa; può essere equipaggiato con manopole.

Tutti e tre i modelli possono essere completati, nella parte posteriore, con accessori per fissaggio su scatole elettriche di vario tipo, a parete o palmare (CSF solo su richiesta).

## GENERAL FEATURES

### Enclosure for Domotics 80x120x10; 15; 25

**Material:** ABS self-extinguishing

The iTouch range is suitable for several applications and is subdivided into three main aesthetics: iShape, STD shape, and CSF.

The first aesthetic called iShape is the most flexible one because it accepts several types of panels on the front, plastic, glass or with integrated touch panel functions.

The second version, STD shape, is the most simple one because it is not necessary the use of a panel but it is enough the equipment with DISPLAY with touch panel integrated function.

The last one, called CSF, is instead more similar to the traditional applications with coordinate colours and front panel closed, suitable to mechanical machinings and printing; it can be equipped with knobs.

All three models can be completed, in the rear part, with fastening accessories on various types of electric enclosures, wall mounting or handheld enclosures (CSF only on request).

## TECHNICAL CUSTOMER CARE

Un NUOVO SERVIZIO ITALTRONIC per qualsiasi Vostra richiesta di documentazione tecnica.

A NEW ITALTRONIC SERVICE for any request of technical documentation.

Download: <http://www.italtronic.info/download/itouch/material>



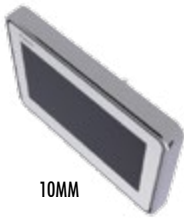

10MM

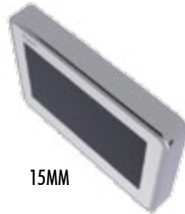

15MM

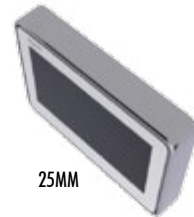

25MM



WHITE



BLACK



503



D.60



WHITE CHROME



BLACK CHROME



HANDHELD



WALL



iTouch

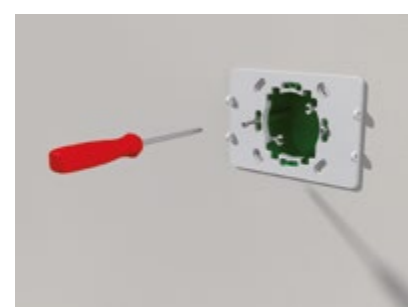
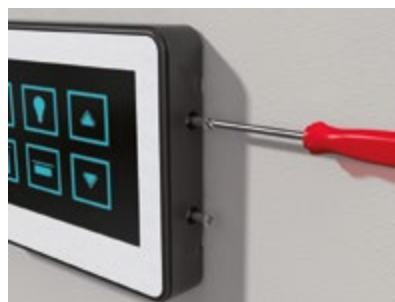
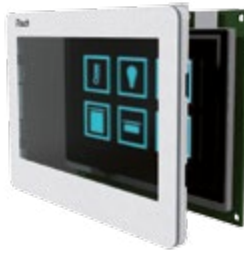

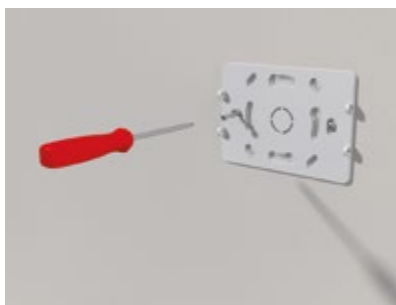

CSF Solo versione 25 mm / Only 25 mm version

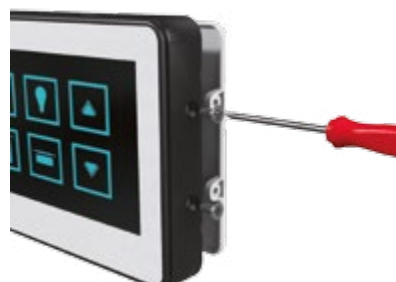
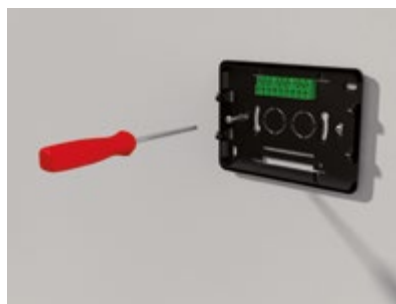
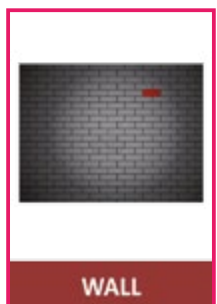

**iShape****iTouch 80x120**

**Contenitore alloggiabile su scatola elettrica, per uso a parete o per uso palmare.**

**Materiale:** ABS autoestinguente

**Colore:** Bianco (altri colori su richiesta)

**CARATTERISTICHE**

La linea iTouch soddisfa le esigenze del progettista elettronico che necessita di un contenitore elettronico dalle molteplici applicazioni a parete oppure per uso palmare. Infatti grazie alla giusta composizione dei kit offerti è possibile montare il dispositivo elettronico finale sulle scatole elettriche più comuni incassate nella parete oppure direttamente sulla parete liscia. E' possibile anche un uso palmare con estetica attuale.

Il contenitore iTouch è studiato per contenere elettronica a display con pannello Touch, oppure per il tradizionale impiego con pannelli piatti di vario tipo, anche in vetro. Il pannello Touch deve essere saldato sulla scheda elettronica.

**iShape****iTouch 80x120**

**Enclosure to be assembled on electric case, for wall use or for handheld use.**

**Material:** ABS self-extinguishing

**Colour:** White (other colours on request)

**FEATURES**

The iTouch range satisfies the exigencies of the electronic designer who needs an electronic enclosure with various wall or handheld applications. In fact, thanks to the right kit composition offered, it is possible to assemble the final electronic device on the most common electric cases inserted in the wall or directly on the flat wall. A handheld use with actual aesthetic is also possible.

The iTouch enclosure has been studied to contain display electronics with Touch panel or for the traditional use with flat panels of various types, even glass panels. The Touch panel must be soldered on the electronic card.

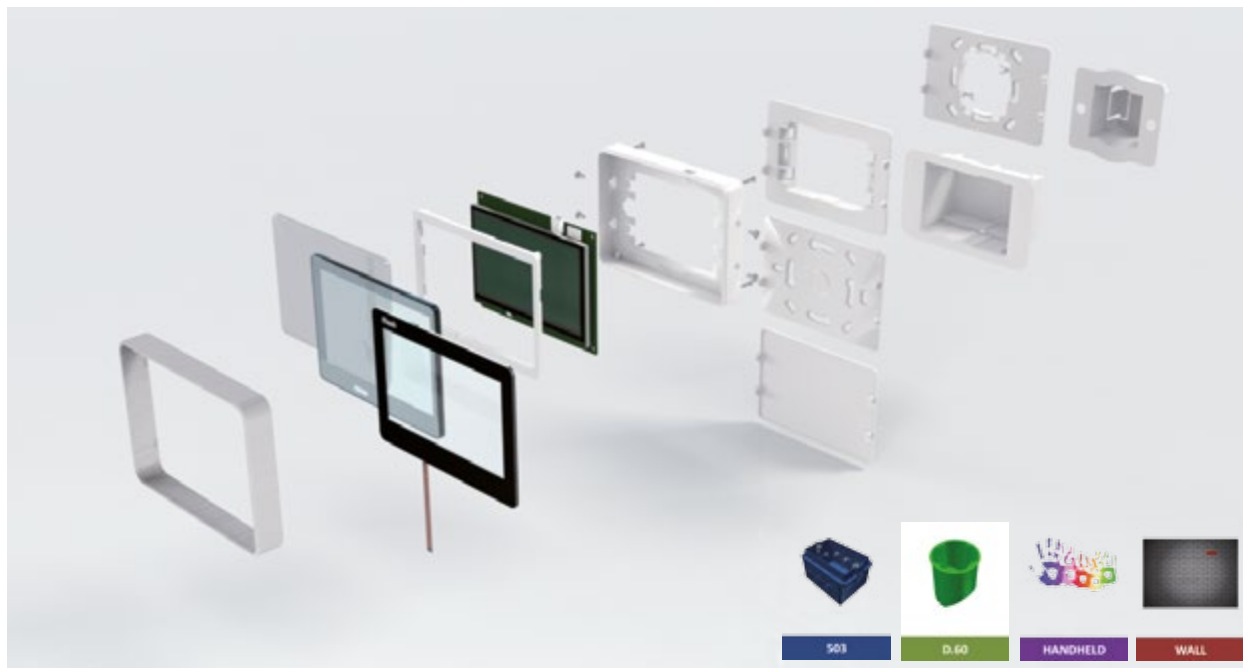
**TECHNICAL CUSTOMER CARE**

Un NUOVO SERVIZIO ITALTRONIC per qualsiasi Vostra richiesta di documentazione tecnica.

A NEW ITALTRONIC SERVICE for any request of technical documentation.

Download: <http://www.italtronic.info/download/itouch/ishape>



Numero Verde  
**800 - 960372**

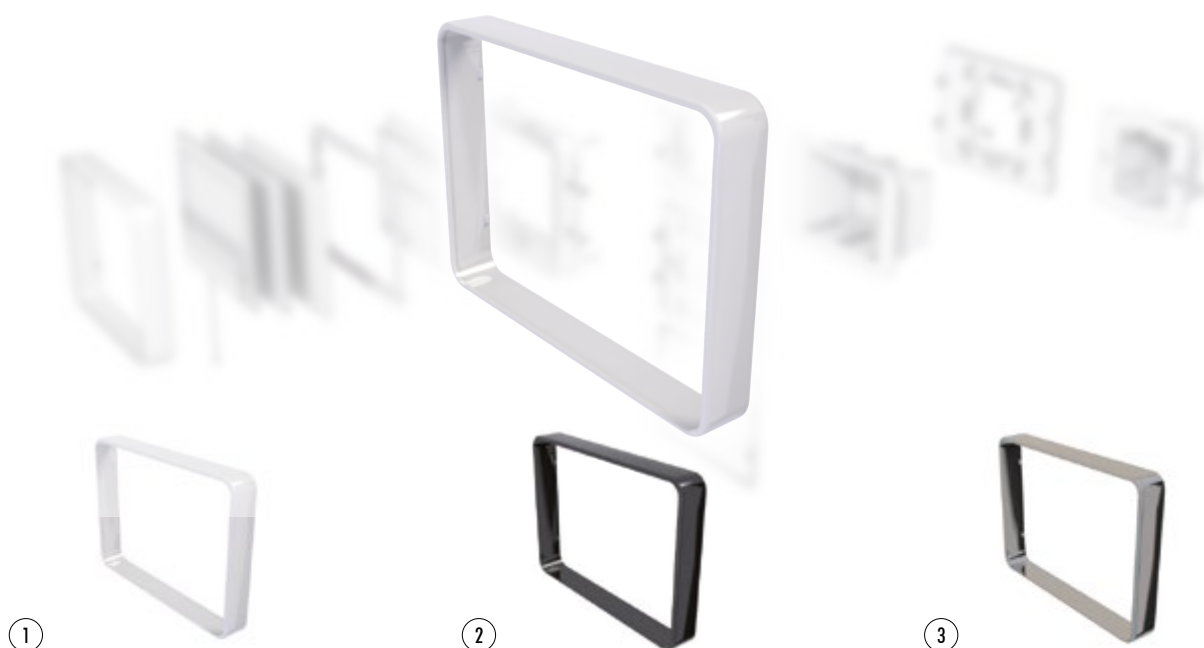

## Anello cornice / Frame ring

CODICE / CODE	REF	COLORE / COLOUR	DESCRIZIONE / DESCRIPTION
P14001305A	①	Bianco / White	Anello cornice H10 / Frame ring H10
P14002305A	①	Bianco / White	Anello cornice H15 / Frame ring H15
P14003305A	①	Bianco / White	Anello cornice H25 / Frame ring H25
P14001105A	②	Nero / Black	Anello cornice H10 / Frame ring H10 *su richiesta / on request
P14002105A	②	Nero / Black	Anello cornice H15 / Frame ring H15 *su richiesta / on request
P14003105A	②	Nero / Black	Anello cornice H25 / Frame ring H25 *su richiesta / on request
P14001135A	③	Cromo / Chrome	Anello cornice H10 / Frame ring H10 *su richiesta / on request
P14002135A	③	Cromo / Chrome	Anello cornice H15 / Frame ring H15 *su richiesta / on request
P14003135A	③	Cromo / Chrome	Anello cornice H25 / Frame ring H25 *su richiesta / on request

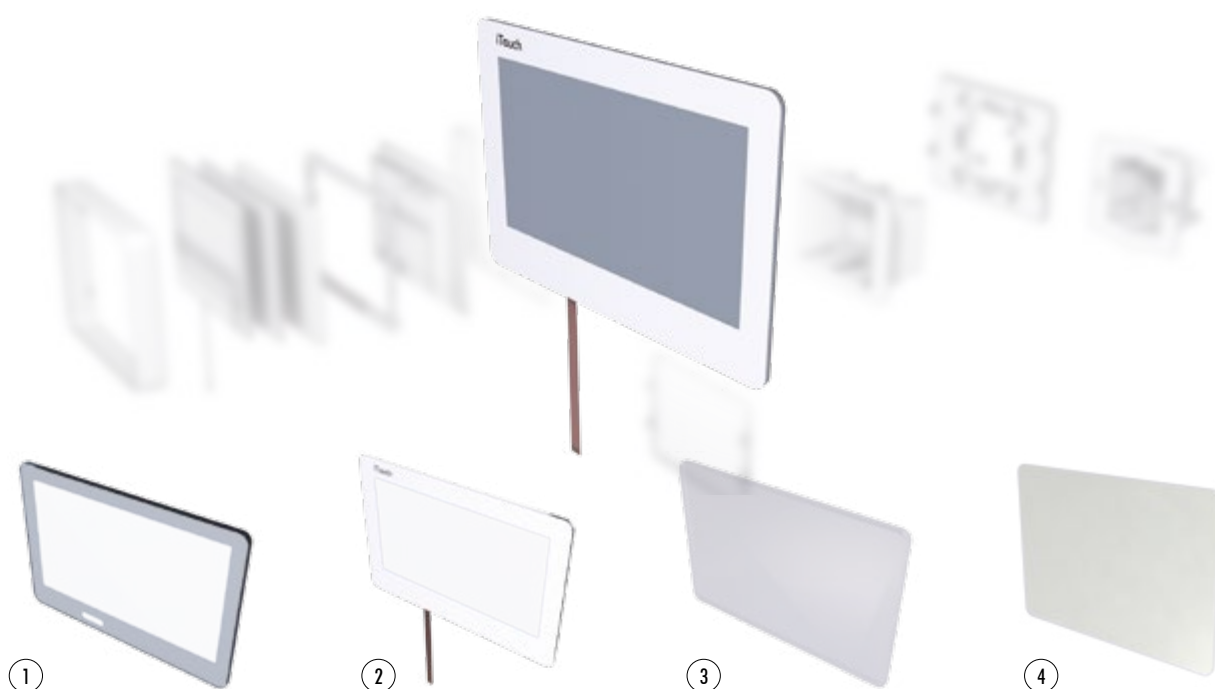

## Pannello / Front panel

CODICE / CODE	REF	COLORE / COLOUR	DESCRIZIONE / DESCRIPTION
P14033700V	①	Trasparente / Transparent	Pannello in vetro frontale / Glass front panel
P14023700V	①	Fumè / Smoked	Pannello in vetro frontale / Glass front panel
P14013700V	①	Specchio / Mirror	Pannello in vetro frontale / Glass front panel
14.TP10000	②	Nero / Black	Pannello touch resistivo frontale / Front touch resistive panel
14.TP30000	②	Bianco / White	Pannello touch resistivo frontale / Front touch resistive panel
14.TP00000	②	Neutro / Neutral	Pannello touch resistivo frontale / Front touch resistive panel
P140013749	③	Neutro / Neutral	Pannello in policarbonato trasparente frontale / Polycarbonate front transparent panel *su richiesta / on request
P140023749	④	Bianco / White	Pannello plastico frontale chiuso / Plastic front panel
P140033749	④	Nero / Black	Pannello plastico frontale chiuso / Plastic front panel closed



## Corpo contenitore / Body case

CODICE / CODE	REF	COLORE / COLOUR	DESCRIZIONE / DESCRIPTION
14.3201310	①	Bianco / White	KIT contenitore H10 / Enclosure KIT H10*
14.3201315	①	Bianco / White	KIT contenitore H15 / Enclosure KIT H15*
14.3201325	①	Bianco / White	KIT contenitore H25 / Enclosure KIT H25*
14.3201110	②	Nero / Black	KIT contenitore H10 / Enclosure KIT H10*
14.3201115	②	Nero / Black	KIT contenitore H15 / Enclosure KIT H15*
14.3201125	②	Nero / Black	KIT contenitore H25 / Enclosure KIT H25*
14.3203325	③	Bianco / White	KIT contenitore H25 / Enclosure KIT H25**
14.3203125	③	Nero / Black	KIT contenitore H25 / Enclosure KIT H25**

NOTA: scegliere il corretto abbinamento con la cornice frontale.

\*Kit contenitore: N.1 corpo contenitore iTouch, n.1 telaio porta display, n.8 viti.

\*\* Kit contenitore: N.1 corpo contenitore iTouch, n.1 telaio con pannello chiuso, n.8 viti.

NOTE: choose the correct matching with the front frame

\*Enclosure kit: N.1 body case iTouch, n.1 display holder frame, 8 screws.

\*\* Enclosure kit: N.1 body case iTouch, n.1 frame with closed panel, 8 screws.

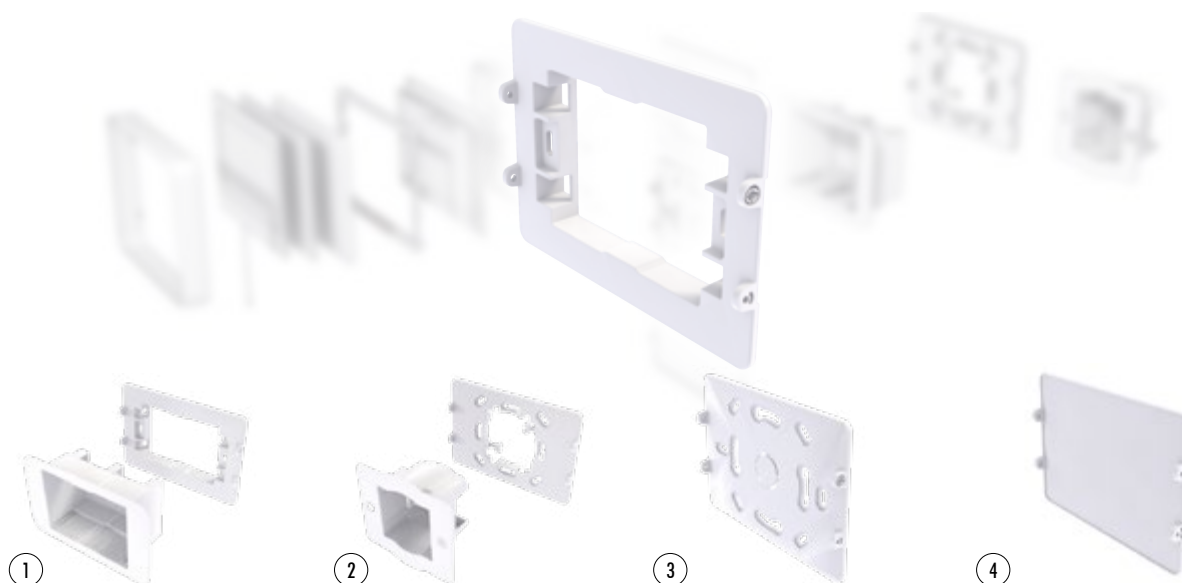

## Placca posteriore / Mounting frame

CODICE / CODE	REF	COLORE / COLOUR	DESCRIZIONE / DESCRIPTION
14.3205001	①	Neutro / Neutral	KIT Placca posteriore per scatola 503 H30 / KIT mounting frame for box 503 H30*
14.3205002	②	Neutro / Neutral	KIT Placca posteriore per scatola Ø60 H30 / KIT mounting frame for box Ø60 H30**
14.3205003	③	Neutro / Neutral	Placca posteriore per uso piatto a parete / Mounting frame for wall mounting
14.3205004	④	Nero / Black	Placca posteriore per uso palmare / Mounting frame for hand-held use
14.3205005	④	Bianco / White	Placca posteriore per uso palmare / Mounting frame for hand-held use
14.3205006	④	Trasparente / Transparent	Placca posteriore per uso palmare / Mounting frame for hand-held use

\*Kit placca posteriore per scatola 503: N.1 contenitore 503, n.1 placca per 503.

\*\* Kit placca posteriore per scatola Ø 60 : N.1 contenitore Ø60, n.1 placca per Ø60.

\*Kit mounting frame for box 503: N.1 enclosure 503, n.1 wall frame for 503.

\*\* Kit mounting frame for box Ø 60 : N.1 enclosure Ø60, n.1 wall frame for Ø60.





### Ricambi / Spare parts

CODICE / CODE	REF	COLORE / COLOUR	DESCRIZIONE / DESCRIPTION
PM10012017		Bianco zincata/Galvanized white	Vite d 2,9 x 6,5 TS per la placca chiusura / Screw d 2,9 x 6,5 TS for closing plate itouch
PM10012018		Bianco zincata/Galvanized white	Vite d 2,9 x 9,5 TS punta tronca per telaio / Screw d 2,9 x 9,5 TS truncated tip for frame
PM10012019		Bianco zincata/Galvanized white	Vite d 2,9 x 19 TS tronca per telaio H25 / Screw d 2,9 x 6,5 TS truncated tip for frame h25

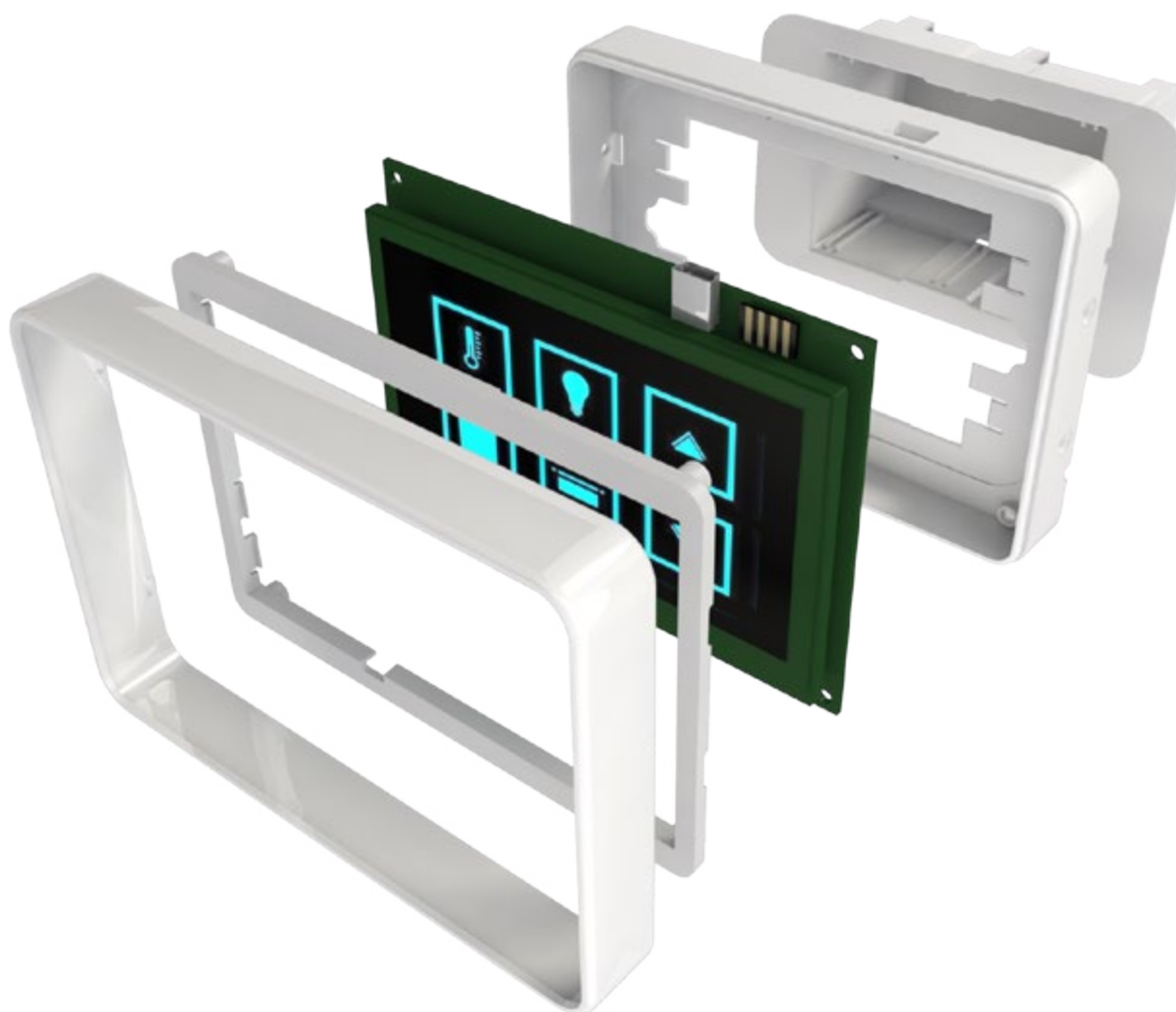



BLACK



WHITE



CHROME

### STD Shape

#### iTouch 80x120

Contenitore alloggiabile su scatola elettrica, per uso a parete o per uso palmare.

**Materiale:** ABS autoestinguente

**Colore:** Bianco (altri colori su richiesta)

#### CARATTERISTICHE

La linea iTouch soddisfa le esigenze del progettista elettronico che necessita di un contenitore elettronico dalle molteplici applicazioni a parete oppure per uso palmare. Infatti grazie alla giusta composizione dei kit offerti è possibile montare il dispositivo elettronico finale sulle scatole elettriche più comuni incassate nella parete oppure direttamente sulla parete liscia. E' possibile anche un uso palmare con estetica attuale.

Il contenitore iTouch è studiato per contenere elettronica a display con pannello Touch, oppure per il tradizionale impiego con pannelli piatti di vario tipo, anche in vetro. Il pannello Touch è già integrato sul display.

### STD Shape

#### iTouch 80x120

Enclosure to be assembled on electric case, for wall use or for handheld use.

**Material:** ABS self-extinguishing

**Colour:** White (other colours on request)

#### FEATURES

The iTouch range satisfies the exigencies of the electronic designer who needs an electronic enclosure with various wall or handheld applications. In fact, thanks to the right kit composition offered, it is possible to assemble the final electronic device on the most common electric cases inserted in the wall or directly on the flat wall. A handheld use with actual aesthetic is also possible.

The iTouch enclosure has been studied to contain display electronics with Touch panel or for the traditional use with flat panels of various types, even glass panels. The Touch panel is already integrated on the display.



### TECHNICAL CUSTOMER CARE

Un NUOVO SERVIZIO ITALTRONIC per qualsiasi Vostra richiesta di documentazione tecnica.

A NEW ITALTRONIC SERVICE for any request of technical documentation.

Download: <http://www.italtronic.info/download/itouch/STDShape>



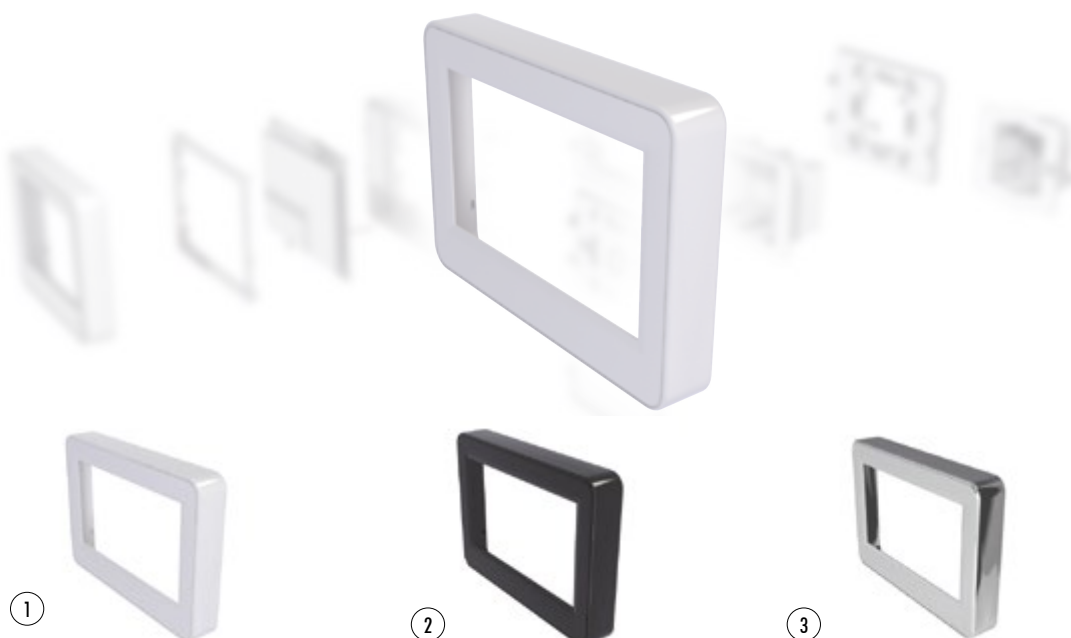

## Anello cornice / Frame ring

CODICE / CODE	REF	COLORE / COLOUR	DESCRIZIONE / DESCRIPTION
P14004305A	①	Bianco / White	Anello cornice H10 / Frame ring H10
P14005305A	①	Bianco / White	Anello cornice H15 / Frame ring H15
P14009305A	①	Bianco / White	Anello cornice H25 / Frame ring H25
P14004105A	②	Nero / Black	Anello cornice H10 / Frame ring H10
P14005105A	②	Nero / Black	Anello cornice H15 / Frame ring H15
P14009105A	②	Nero / Black	Anello cornice H25 / Frame ring H25
P14004135A	③	Cromo / Chrome	Anello cornice H10 / Frame ring H10
P14005135A	③	Cromo / Chrome	Anello cornice H15 / Frame ring H15
P14009135A	③	Cromo / Chrome	Anello cornice H25 / Frame ring H25



## Corpo contenitore / Body case

CODICE / CODE	REF	COLORE / COLOUR	DESCRIZIONE / DESCRIPTION
14.3201310	①	Bianco / White	KIT contenitore H10 / Enclosure KIT H10*
14.3201315	①	Bianco / White	KIT contenitore H15 / Enclosure KIT H15*
14.3201325	①	Bianco / White	KIT contenitore H25 / Enclosure KIT H25*
14.3201110	②	Nero / Black	KIT contenitore H10 / Enclosure KIT H10*
14.3201115	②	Nero / Black	KIT contenitore H15 / Enclosure KIT H15*
14.3201125	②	Nero / Black	KIT contenitore H25 / Enclosure KIT H25*

NOTA: scegliere il corretto abbinamento con la cornice frontale.

\*Kit contenitore: N.1 corpo contenitore iTouch, n.1 telaio porta display, n.8 viti.

NOTE: choose the correct matching with the front frame

\*Enclosure kit: N.1 body case iTouch, n.1 display holder frame, 8 screws.

# STD Shape iTouch



## Placca posteriore / Mounting frame

CODICE / CODE	REF	COLORE / COLOUR	DESCRIZIONE / DESCRIPTION
14.3205001	①	Neutro / Neutral	KIT placca posteriore per scatola 503 H30 / KIT Mounting frame for box 503 H30 *
14.3205002	②	Neutro / Neutral	KIT placca posteriore per scatola Ø60 H30 / KIT Mounting frame for box Ø60 H30 **
14.3205003	③	Neutro / Neutral	Placca posteriore per uso piatto a parete / Mounting frame for wall mounting
14.3205004	④	Nero / Black	Placca posteriore per uso palmare / Mounting frame for hand-held use
14.3205005	④	Bianco / White	Placca posteriore per uso palmare / Mounting frame for hand-held use
14.3205006	④	Trasparente / Transparent	Placca posteriore per uso palmare / Mounting frame for hand-held use

\*Kit placca posteriore per scatola 503: N.1 contenitore 503, n.1 placca per 503.

\*\*Kit placca posteriore per scatola Ø 60 : N.1 contenitore Ø60, n.1 placca per Ø60.

\*Kit mounting frame for box 503: N.1 enclosure 503, n.1 wall frame for 503.

\*\*Kit mounting frame for box Ø 60 : N.1 enclosure Ø60, n.1 wall frame for Ø60.

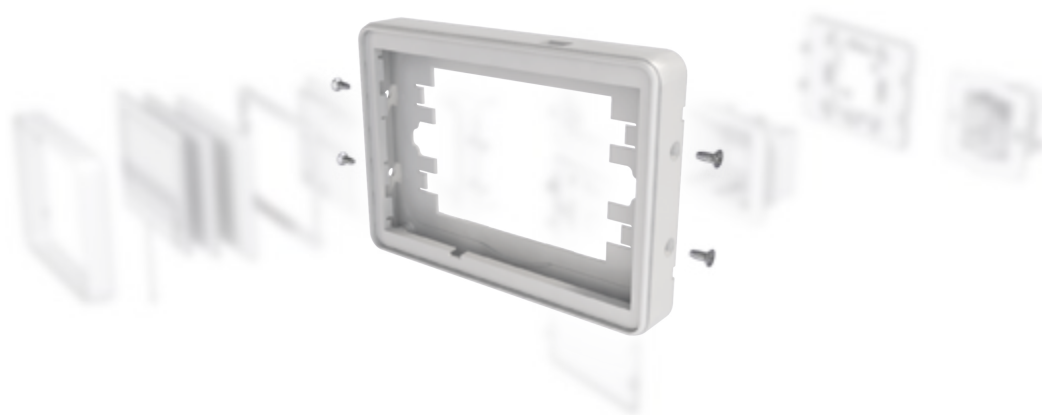

## Ricambi / Spare parts

CODICE / CODE	REF	COLORE / COLOUR	DESCRIZIONE / DESCRIPTION
PM10012017		Bianco zincata/Galvanized white	Vite d 2,9 x 6,5 TS per la placca chiusura iTouch/ Screw d 2,9 x 6,5 TS for closing plate iTouch
PM10012018		Bianco zincata/Galvanized white	Vite d 2,9 x 9,5 TS punta tronca per telaio / Screw d 2,9 x 9,5 TS truncated tip for frame
PM10012019		Bianco zincata/Galvanized white	Vite d 2,9 x 19 TS tronca per telaio H25 / Screw d 2,9 x 6,5 TS truncated tip for frame h25
P1400000G			Guarnizione per anello STD Shape / itouch std shape gasket

## iShape / STD Shape iTouch



## ORDINA IN TRE PASSI

1. Scegli la cornice anteriore da associare all'estetica che preferisci iShape oppure STD Shape.
2. Scegli il kit corpo contenitore con colore abbinato alla cornice anteriore. Devi acquistare anche il pannello touch nel colore abbinato solo se hai scelto la forma iShape. La scheda elettronica deve essere ordinata in accordo con l'estetica scelta. Italtronic fornisce su richiesta i nomi dei produttori e rispettivi data sheet.
3. Scegli la finitura posteriore in accordo con l'applicazione che devi sviluppare: per scatola elettrica 503, per scatola elettrica DIAM 60, per assemblaggio diretta a parete piatta oppure per uso palmare.

**NOTA:** la versione CSF è dettagliatamente indicata nell'apposita sezione perché leggermente diversa.

## THREE STEPS ORDER

1. Choose the front frame to match with the aesthetic that you prefer, iShape or Standard shape.
2. Choose the body case kit with colour matching the front frame. You have to buy also the touch panel in the colour-matching only if you have chosen the iShape. The electronic card must be ordered according to the chosen aesthetic. Italtronic supplies the name of the producers and relative datasheets on request.
3. Choose the rear finishing according to the application that you have to develop: for electric case 503, for electric case DIAM 60, for direct assembling on flat wall or for handheld use.

**NOTE:** the CSF version is indicated in detail in the relative section, because slightly different.





BLACK



WHITE

Solo per profondità 25mm/ Only  
25mm thickness



BLACK CHROME



WHITE CHROME

## CSF

### iTouch 80x120 Contenitore per uso a parete

**Materiale:** ABS autoestinguente

**Colore:** Bianco (altri colori su richiesta)

#### CARATTERISTICHE

Il contenitore versione CSF della linea iTouch soddisfa le esigenze del progettista elettronico che necessita di un contenitore per elettronica da parete con sistema di conversione rapido: il sistema CSF prevede il cablaggio dei cavi sui morsetti con vite alloggiati sulla base del contenitore iTouch, a sua volta avvitata sulla parete; di seguito l'equipaggiamento elettronico è connesso semplicemente, grazie agli appositi pins diritti saldati nella scheda elettronica e sporgente nella parte posteriore, inserendolo nella femmina CSF già cablata e fissata a parete.

Il kit iTouch CSF è disponibile solo in versione 25 mm speciale con pannello chiuso in colore coordinato con la scatola e gli accessori, come le manopole. A richiesta disponibili versioni speciali con pannello trasparente o touch resistivo.

## CSF

### iTouch 80x120 Enclosure for wall use

**MATERIAL:** ABS self-extinguishing

**Colour:** White (other colours on request)

#### FEATURES

The enclosure CSF version of iTouch range satisfies the exigencies of the electronic designer who needs an electronic enclosure for wall mounting with rapid conversion system: CSF system provides the wiring of the cables on the terminals with screw located on the base of the iTouch case, which is screwed to the wall; then the electronic equipment is simply connected thanks to the special straight pins welded on the electronic card and protruding in the rear part, inserting it in the female CSF wired and fixed to the wall.

The kit iTouch CSF is available only in the version 25mm special with closed panel in colour-matching with the enclosure and the accessories, like the knobs. Available on request special versions with transparent panel or touch resistive.

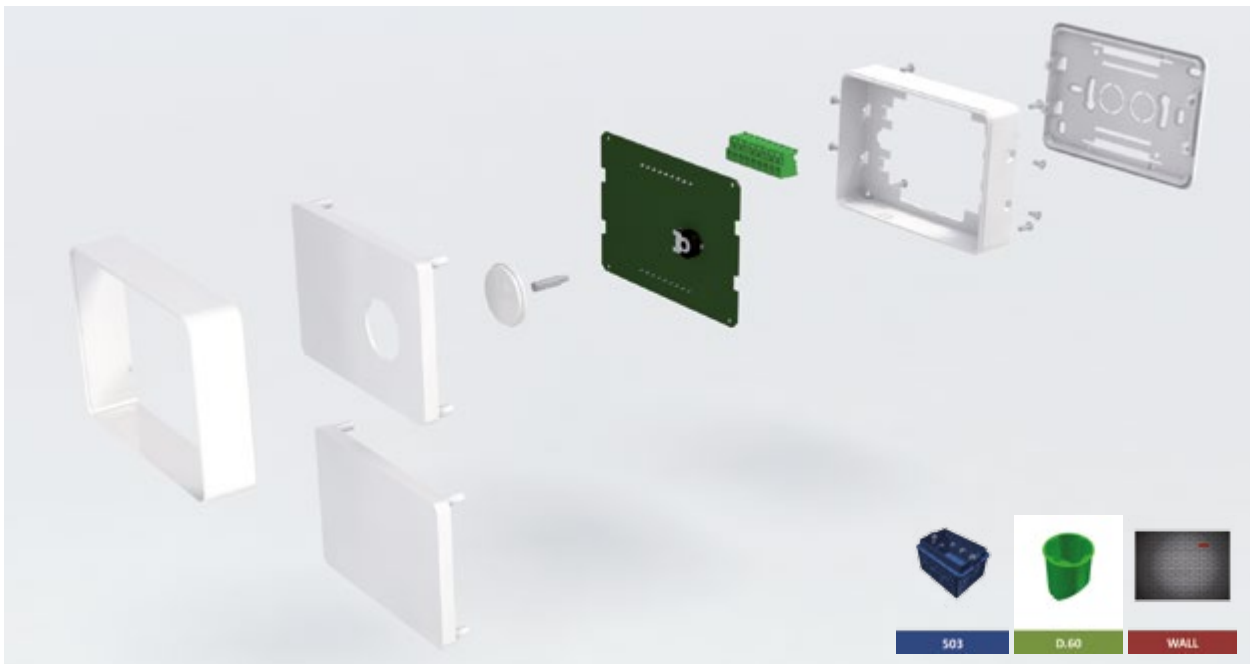

## TECHNICAL CUSTOMER CARE

Un NUOVO SERVIZIO ITALTRONIC per qualsiasi Vostra richiesta di documentazione tecnica.

A NEW ITALTRONIC SERVICE for any request of technical documentation.

Download: <http://www.italtronic.info/download/itouch/CSF>



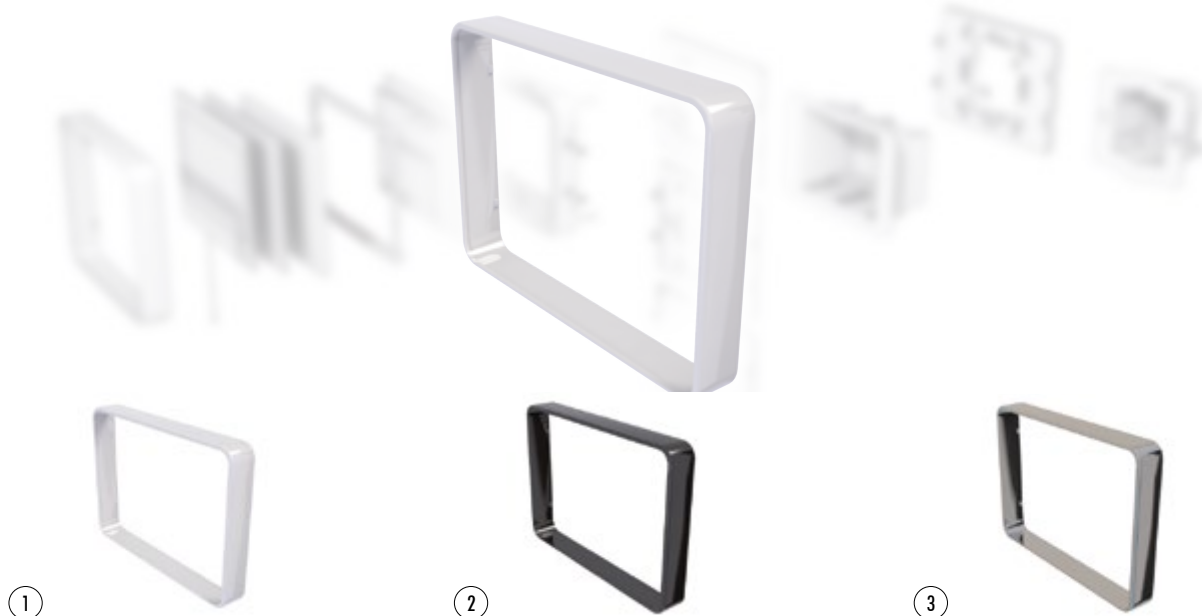

## Anello cornice / Frame ring

CODICE / CODE	REF	COLORE / COLOUR	DESCRIZIONE / DESCRIPTION
P14001305A	①	Bianco / White	Anello cornice H10 / Frame ring H10
P14002305A	①	Bianco / White	Anello cornice H15 / Frame ring H15
P14003305A	①	Bianco / White	Anello cornice H25 / Frame ring H25
P14001105A	②	Nero / Black	Anello cornice H10 / Frame ring H10 *su richiesta / on request
P14002105A	②	Nero / Black	Anello cornice H15 / Frame ring H15 *su richiesta / on request
P14003105A	②	Nero / Black	Anello cornice H25 / Frame ring H25 *su richiesta / on request
P14001135A	③	Cromo / Chrome	Anello cornice H10 / Frame ring H10 *su richiesta / on request
P14002135A	③	Cromo / Chrome	Anello cornice H15 / Frame ring H15 *su richiesta / on request
P14003135A	③	Cromo / Chrome	Anello cornice H25 / Frame ring H25 *su richiesta / on request

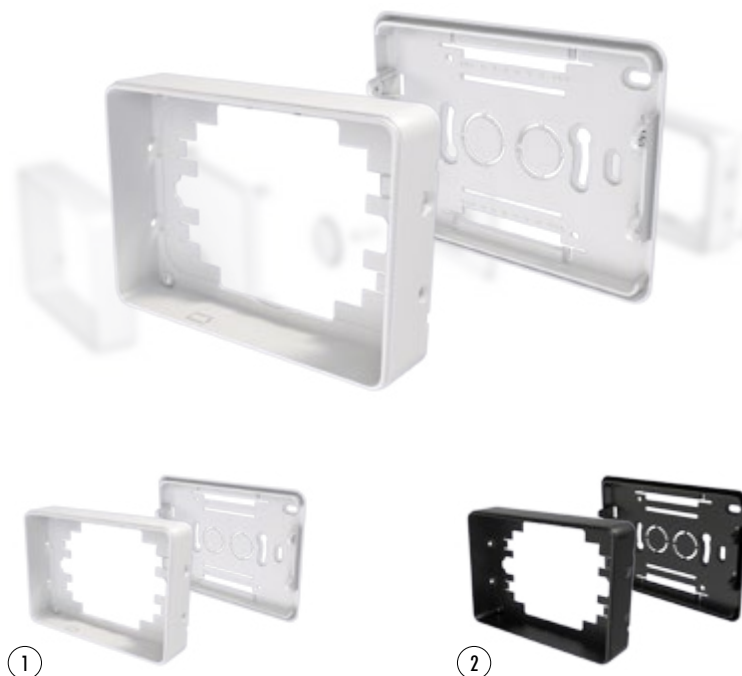

## Corpo contenitore / Body enclosure

CODICE / CODE	REF	COLORE / COLOUR	DESCRIZIONE / DESCRIPTION
14.3206310	①	Bianco / White	Corpo contenitore H10 con base CSF/ Body enclosure H10 with CSF base type
14.3206315	①	Bianco / White	Corpo contenitore H15 con base CSF/ Body enclosure H15 with CSF base type
14.3206325	①	Bianco / White	Corpo contenitore H25 con base CSF/ Body enclosure H25 with CSF base type
14.3206110	②	Nero / Black	Corpo contenitore H10 con base CSF/ Body enclosure H10 with CSF base type
14.3206115	②	Nero / Black	Corpo contenitore H15 con base CSF/ Body enclosure H15 with CSF base type
14.3206125	②	Nero / Black	Corpo contenitore H25 con base CSF/ Body enclosure H25 with CSF base type



## Telaio / Frame

CODICE / CODE	REF	COLORE / COLOUR	DESCRIZIONE / DESCRIPTION
P14001305T	①	Bianco / White	Telaio H10/15 / Frame H10/15
P14003305T	①	Bianco / White	Telaio H25 con torretta 2mm / Frame H25 with turret 2mm



## Pannello / Panel

CODICE / CODE	REF	COLORE / COLOUR	DESCRIZIONE / DESCRIPTION
P14006305T	①	Bianco / White	Pannello chiuso CSF base H10 / Closed panel CSF base H10
P14005305T	①	Bianco / White	Pannello chiuso CSF base H15 / Closed panel CSF base H15
P14002305T	①	Bianco / White	Pannello chiuso CSF base H25 / Closed panel CSF base H25
P14006105T	②	Nero / Black	Pannello chiuso CSF base H10 / Closed panel CSF base H10
P14005105T	②	Nero / Black	Pannello chiuso CSF base H15 / Closed panel CSF base H15
P14002105T	②	Nero / Black	Pannello chiuso CSF base H25 / Closed panel CSF base H25
P14033700V	③	Trasparente / Transparent	Pannello in vetro frontale iTouch / Glass front panel iTouch
P14023700V	③	Fumè / Smoked	Pannello in vetro frontale iTouch / Glass front panel iTouch
P14013700V	③	Specchio / Mirror	Pannello in vetro frontale iTouch / Glass front panel iTouch
14.TP10000	④	Nero / Black	Pannello touch resistivo frontale / Front touch resistive panel
14.TP30000	④	Bianco / White	Pannello touch resistivo frontale / Front touch resistive panel
14.TP00000	④	Neutro / Neutral	Pannello touch resistivo frontale / Front touch resistive panel
P140013749	⑤	Neutro / Neutral	Pannello in policarbonato trasparente frontale / Polycarbonate front transparent panel *su richiesta /on request



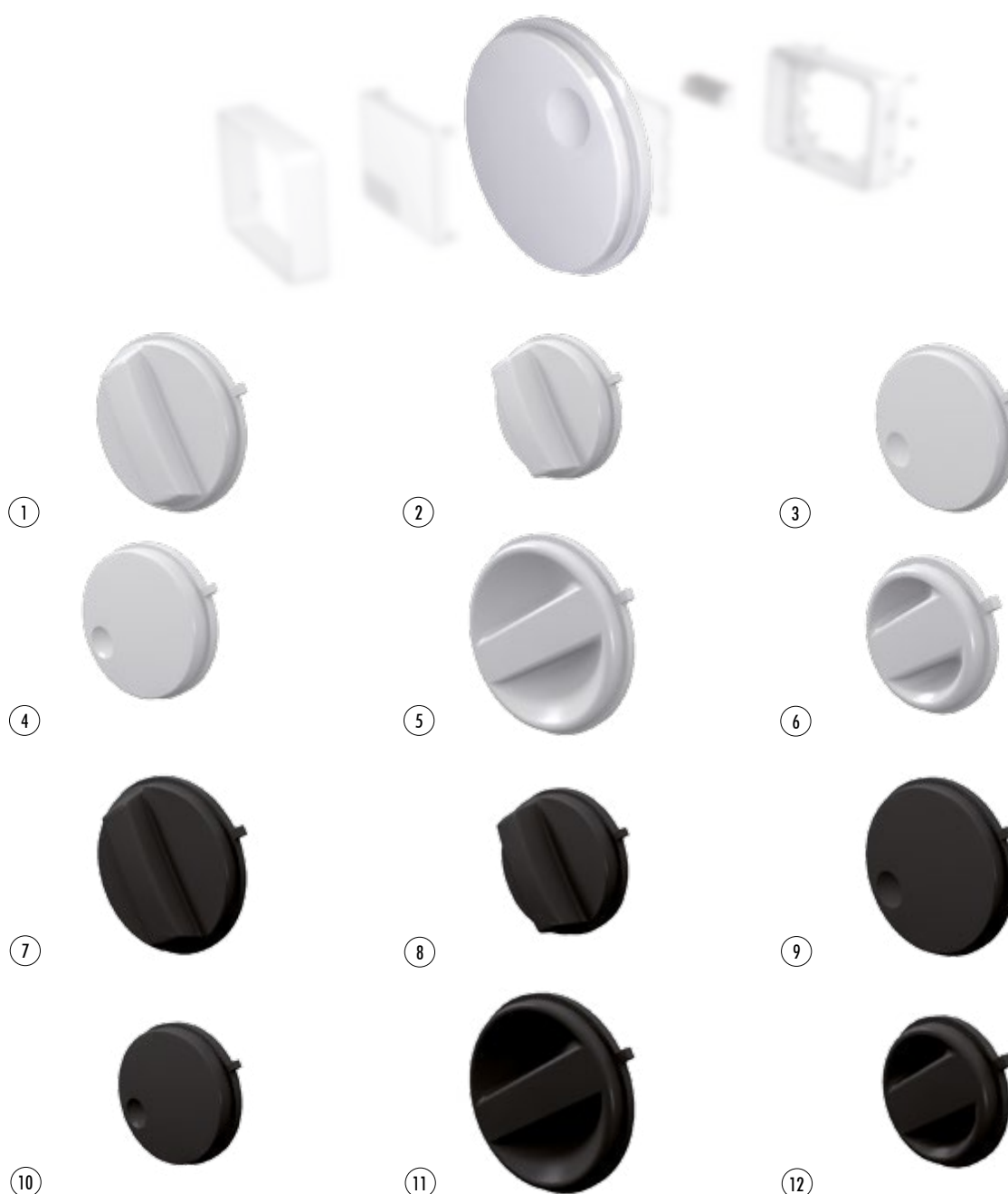

### Manopola / Handle

CODICE / CODE	REF	COLORE / COLOUR	DESCRIZIONE / DESCRIPTION
P14001305M	①	Bianco / White	Manopola Ø 30, alto profilo, con levetta in rilievo / Handle Ø 30, high profile, with lever in relief
P14003305M	②	Bianco / White	Manopola Ø 20, alto profilo, con levetta in rilievo / Handle Ø 20, high profile, with lever in relief
P14004305M	③	Bianco / White	Manopola Ø 30, basso profilo, con nicchia tonda / Handle Ø 30, low profile, with round niche
P14005305M	④	Bianco / White	Manopola Ø 20, basso profilo, con nicchia tonda / Handle Ø 20, low profile, with round niche
P14006305M	⑤	Bianco / White	Manopola Ø 30, basso profilo, con levetta incassata / Handle Ø 30, low profile, with recessed lever
P14007305M	⑥	Bianco / White	Manopola Ø 20, basso profilo, con levetta incassata / Handle Ø 20, low profile, with recessed lever
P14001105M	⑦	Nero / Black	Manopola Ø 30, alto profilo, con levetta in rilievo / Handle Ø 30, high profile, with lever in relief
P14003105M	⑧	Nero / Black	Manopola Ø 20, alto profilo, con levetta in rilievo / Handle Ø 20, high profile, with lever in relief
P14004105M	⑨	Nero / Black	Manopola Ø 30, basso profilo, con nicchia tonda / Handle Ø 30, low profile, with round niche
P14005105M	⑩	Nero / Black	Manopola Ø 20, basso profilo, con nicchia tonda / Handle Ø 20, low profile, with round niche
P14006105M	⑪	Nero / Black	Manopola Ø 30, basso profilo, con levetta incassata / Handle Ø 30, low profile, with recessed lever
P14007105M	⑫	Nero / Black	Manopola Ø 20, basso profilo, con levetta incassata / Handle Ø 20, low profile, with recessed lever
P14000001P			Kit perni per manopole / Kit pins for handles

### Ricambi/ Spare parts

CODICE / CODE	REF	COLORE / COLOUR	DESCRIZIONE / DESCRIPTION
PM10012017		Bianco zincata/Galvanized white	Vite d 2,9 x 6,5 TS per la placca chiusura iTouch / Screw d 2,9 x 6,5 TS for closing plate iTouch
PM10012018		Bianco zincata/Galvanized white	Vite d 2,9 x 9,5 TS punta tronca per telaietto / Screw d 2,9 x 9,5 TS truncated tip for frame
PM10012019		Bianco zincata/Galvanized white	Vite d 2,9 x 19 TS tronca per telaio H25 / Screw d 2,9 x 6,5 TS truncated tip for frame h25

# CSF iTouch

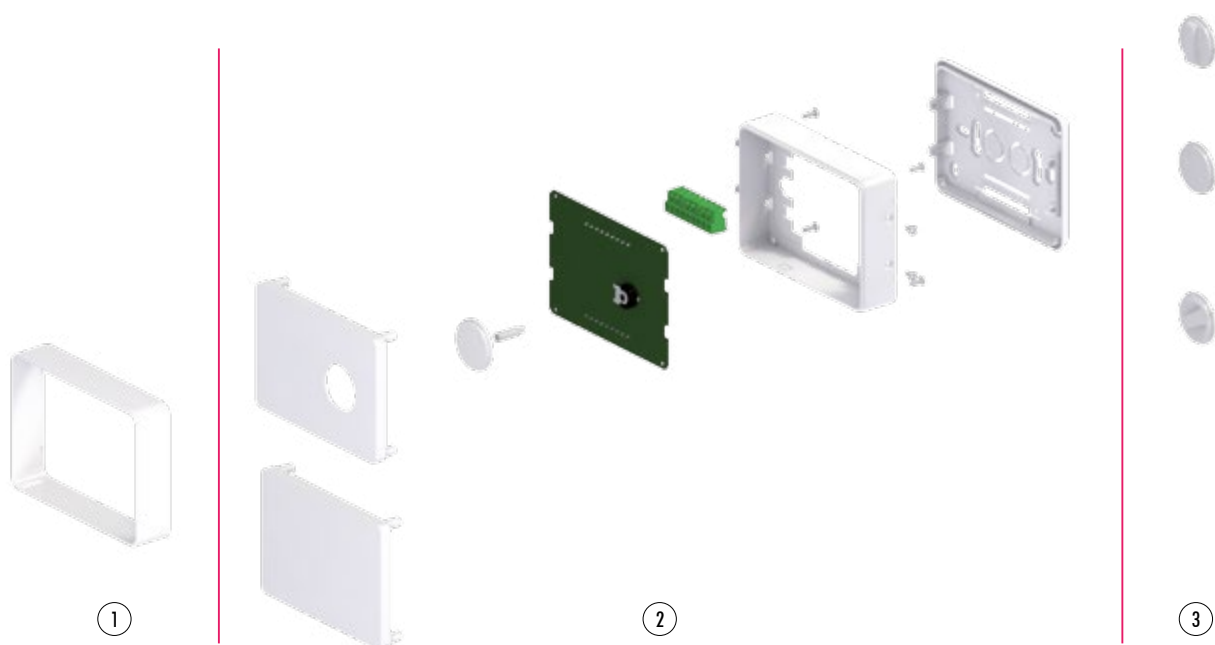

## ORDINA IN POCHI PASSI

1. Scegli la cornice anteriore da associare all'estetica che preferisci.
2. Scegli il kit corpo contenitore con colore abbinato.
3. Scegli le eventuali manopole o chiedi la foratura per posizionare le manopole dove ritieni opportuno.

## ORDER IN A FEW STEPS

1. Choose the front frame to match with the aesthetic you prefer .
2. Choose the body case kit with colour- matching.
3. Choose the eventual knobs or ask for a milling to place the knobs where it is more appropriate for you.





VERNICIATURA PER COLORI SPECIALI /  
PAINT FOR SPECIAL COLOURS

STAMPA DIGITALE & LAVORAZIONI MECCANICHE  
su pannelli in PLASTICA o VETRO /  
DIGITAL PRINTING AND MECHANICAL MACHININGS  
IN PLASTIC OR GLASS panels.



iShape

①

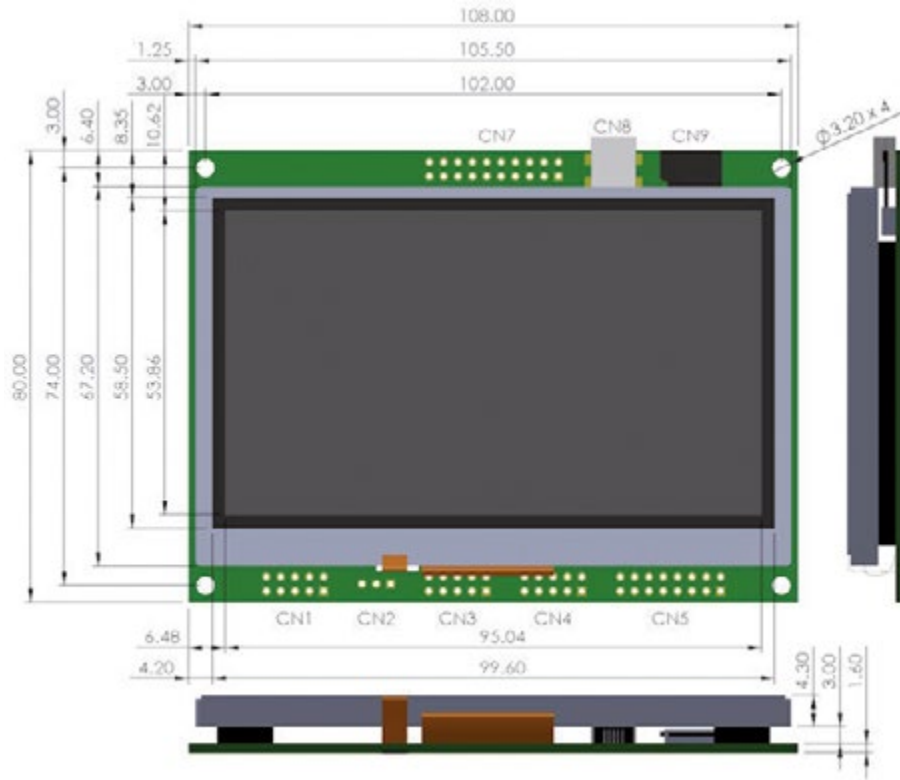

STD Shape

②

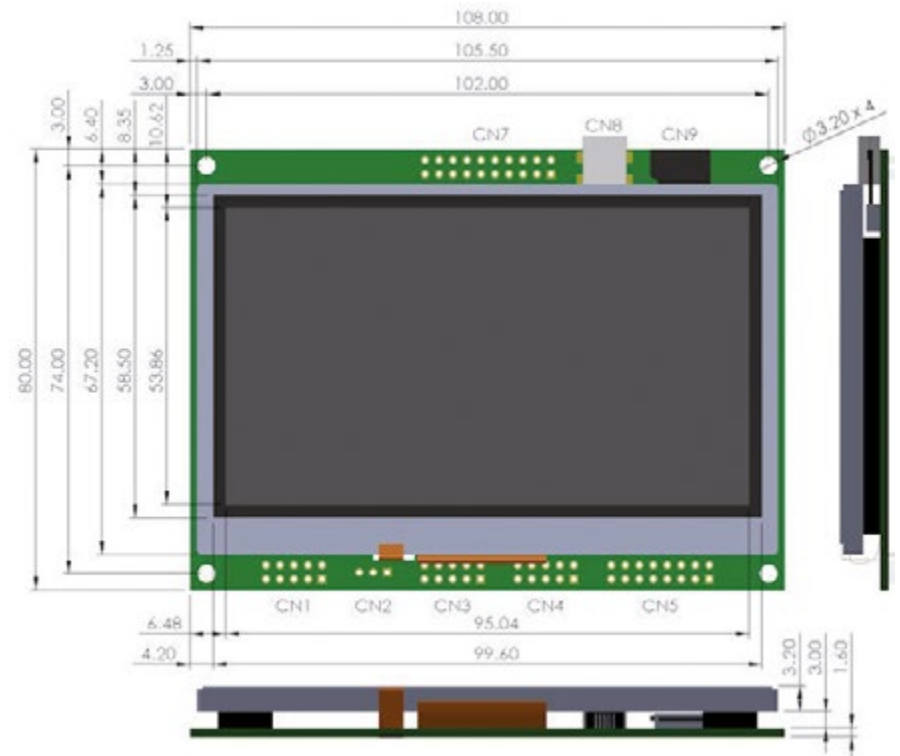

CODICE / CODE	REF	COLORE / COLOUR	DESCRIZIONE / DESCRIPTION
14.TFT4302	①		Display 4.3" con pannello touch integrato con controllo elettronico / Display 4.3" with touch panel integrated and electronic driver
14.TFT4301	②		Display 4.3" senza pannello touch con controllo elettronico / Display 4.3" without touch panel and with electronic driver

Disponibile anche il solo Display senza driver elettronico e altre tipologie di schede driver su richiesta.

Available even only Display without electronic driver and other types of driver cards on request.

**TECHNICAL CUSTOMER CARE**

Un NUOVO SERVIZIO ITALTRONIC per qualsiasi Vostra richiesta di documentazione tecnica.

A NEW ITALTRONIC SERVICE for any request of technical documentation.

Download: <http://www.italtronic.info/download/itouch/display>



TECHNICAL INFO PRINTED CIRCUIT BOARD iTouch

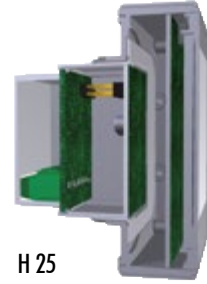
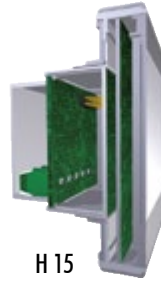

503

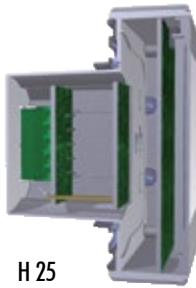
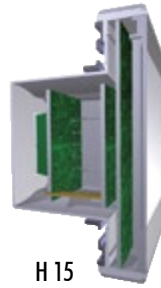
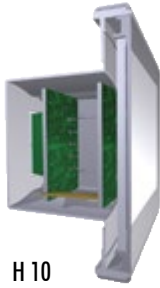

Ø60

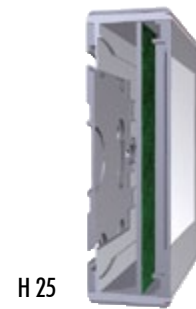

WALL

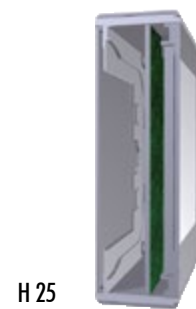

HANDHELD

TECHNICAL CUSTOMER CARE

Un NUOVO SERVIZIO ITALTRONIC per qualsiasi Vostra richiesta di documentazione tecnica.  
 A NEW ITALTRONIC SERVICE for any request of technical documentation.

Download: <http://www.italtronic.info/download/itouch/PCB>





Muro / Wall 503.1

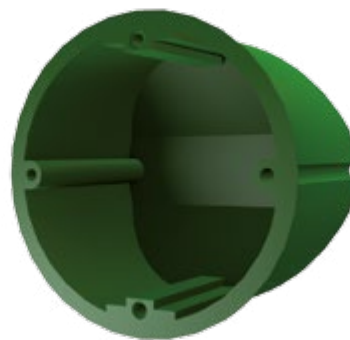

Cartongesso/Plasterboard Ø 60.1



Muro / Wall 503.2



Cartongesso/Plasterboard Ø 60.2

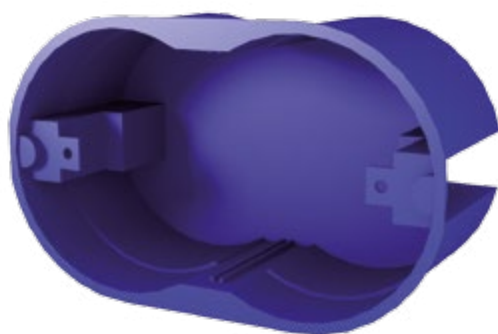

Cartongesso/Plasterboard 503.3



Cartongesso/Plasterboard Ø 60.3

## TECHNICAL CUSTOMER CARE

Un NUOVO SERVIZIO ITALTRONIC per qualsiasi Vostra richiesta di documentazione tecnica.

A NEW ITALTRONIC SERVICE for any request of technical documentation.

Download: <http://www.italtronic.info/download/itouch/electricenclosure>



# Note

A series of horizontal dashed lines for writing notes.

**italtronic**  
enclosures for electronic

**Italtronic Srl**

Via Austria 25/D  
35127 Padova - Italy  
T. +39 049 8947150  
F. +39 049 8947151  
[www.italtronic.com](http://www.italtronic.com)

